

Departamento de Projetos

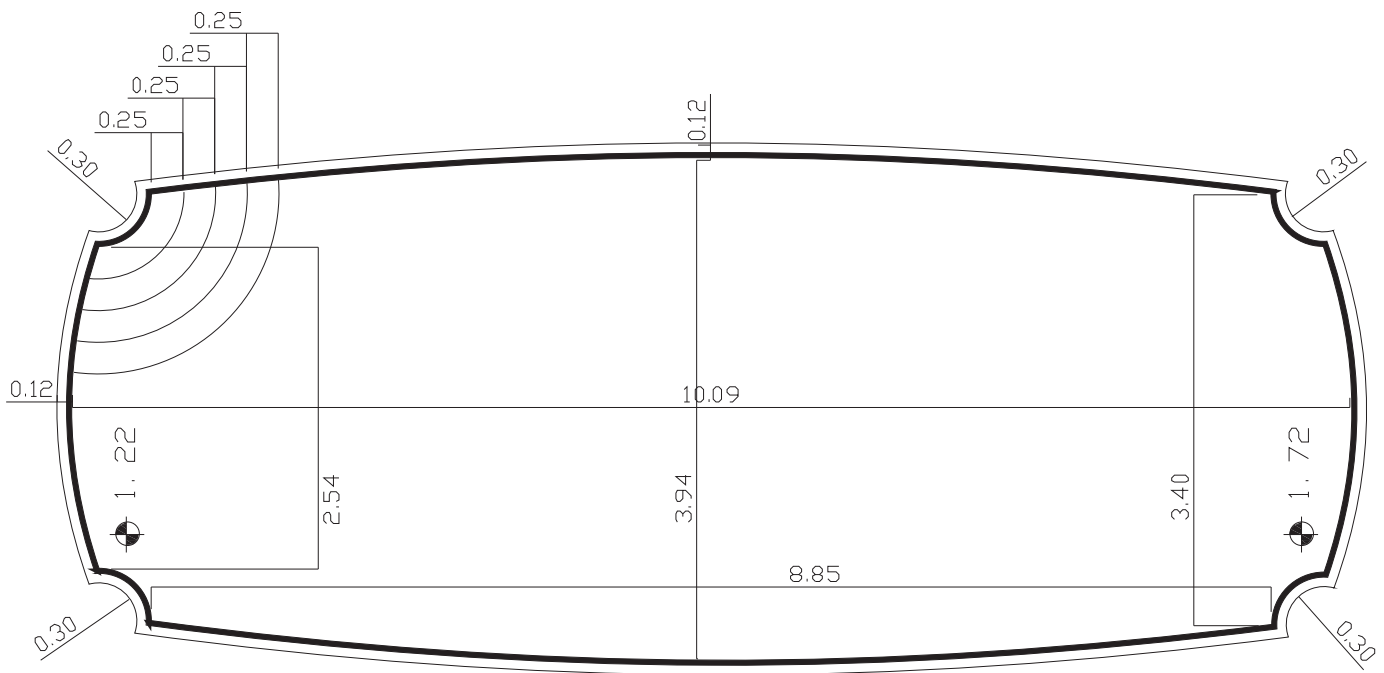

OURO 22



CORTE A-A

